

Pneumatically operated tank bottom valve ELEMENT for decentralized automation



- Zero deadleg monoblock without welds
- Diaphragm hermetically separates the fluids from the operating mechanism
- Easy integration of ELEMENT automation units
- Stainless steel body with weld ends
- FDA/3A quality certifications

Actuator with 360° rotation possibility

Type 2105 can be combined with...



Type 8691
Control Head



Type 8695
Control Head



Type 8690
Pneumatic Control Unit



Type 8697
Pneumatic Control Unit

The Bürkert Tank Bottom Valve Type 2105 is designed for control of ultra pure, sterile, aggressive or abrasive fluids. Enables especially optimal filling and emptying vessels with less dead leg.

The valve body consists of a block with with no weld seam, machined out of high quality stainless steel. The Tank Bottom Valve has two welding bevels to ease the welding and valve positioning operations.

The high quality diaphragms separate hermetically critical fluids from the actuator. The pneumatic actuator is optimized for decentralized automation through ELEMENT pneumatic automation units. The fully integrated system has a compact and smooth design, integrated pneumatic lines, IP65/67, NEMA Type 4X protection class and superior chemical resistance.

Technical data					
Orifice	DN8... DN50				
Body material	<ul style="list-style-type: none"> ▪ Stainless steel 1.4435 / 316 L ▪ Stainless steel 1.4435BN2 / ASME BPE Fe < 0.5% / C ≤ 0.03%				
Diaphragm materials	EPDM (AD), PTFE/EPDM (EA), advanced PTFE/EPDM (EU), Gylon®/EPDM laminated (ER), FKM (FF)				
Actuator material	<table border="0"> <tr> <td>Actuator</td> <td>PPS</td> </tr> <tr> <td>Cover</td> <td>Stainless steel 1.4561 (316Ti)</td> </tr> </table>	Actuator	PPS	Cover	Stainless steel 1.4561 (316Ti)
Actuator	PPS				
Cover	Stainless steel 1.4561 (316Ti)				
Pilot air ports	Stainless steel 1.4305				
Surface finish (others on request)	<ul style="list-style-type: none"> ▪ inside mechanical polished ▪ inside electro polished <ul style="list-style-type: none"> ▪ Ra ≤ 0.5 µm (ASME BPE SF1) (external Ra ≤ 1.6 µm) ▪ Ra ≤ 0.38 µm (ASME BPE SF4 / DIN HE4) (external Ra ≤ 1.6 µm) 				
Media temperature	EPDM (AD) -10 ... +143 °C (steam sterilisation +150 °C for 60 min) PTFE/EPDM (EA) -10 ... +130 °C (steam sterilisation +140 °C for 60 min) PTFE/EPDM (EU) -5 ... +143 °C (steam sterilisation +150 °C for 60 min) GYLON®/EPDM laminated (ER) -5 ... +130 °C (steam sterilisation +140 °C for 60 min) FKM (FF) 0 ... +130 °C (not recommended for steam)				
Ambient temperature	+ 5 ... + 60 °C				
Control medium	Neutral gases, air				
Max. pilot pressure	max. 10 bar; Actuator size 130 mm 7 bar				

DTS 1000204567 EN Version: M Status: RL (released | freigegeben | valide) printed: 18.10.2019

Content

Valve specifications		System spec. On/Off ELEMENT		Request for quotation	
	Type 2105		Type 8801-TC	Type 8801-TC	
Technical data & ordering info.	p. 1 ... 6	Ordering info. & technical data	p. 7 ... 8		p. 9 ... 11

Ordering information for decentralized automation of On/Off ELEMENT valve system Typ 8801-TC

A decentralized, automated **On/Off ELEMENT valve system Type 8801-TB** consists of a **T-valve Type 2105** and a valve actuation system control head **Type 8691/8695** or a pneumatic control unit **Type 8690/8697** (see separate datasheets).

For the configuration of further valve systems please use the "Request for quotation" on p. 9 ... 11.

You order two components and receive a complete assembled and certified valve.

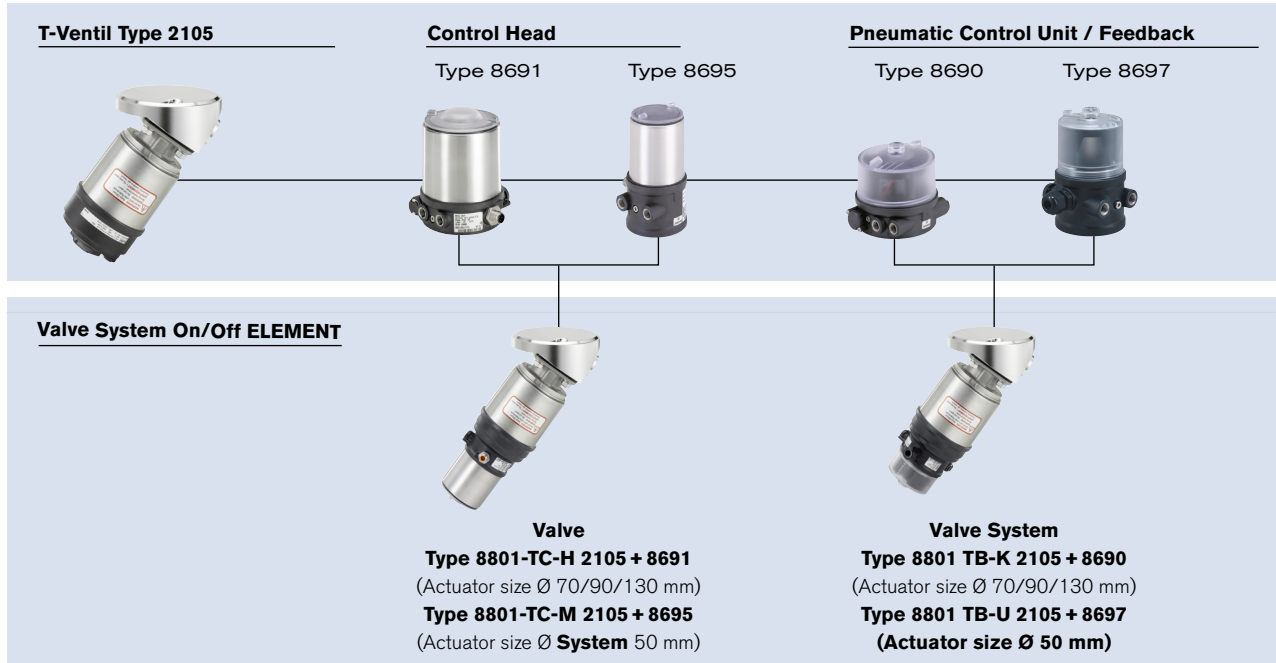

Control Head



Type 8691
 Actuator size Ø 70/90/130 mm

[More info.](#)



Type 8695
 Actuator size Ø 50 mm

[More info.](#)

The Control Head Type 8691/ 8695 is optimised for integrated mounting on the 21XX process valve series. The registration of the valve end position is done through a contactless analog position sensor, which automatically recognises and saves the valve end position through the Teach function when starting up. The integrated pilot valve controls single or double-acting actuators. The status of the valve is shown through high power coloured LEDs.

Features

- High power coloured Status-LEDs
- Contactless inductive position sensor
- Pilot valve with manual override
- Teach function for automatic registration of valve positions
- Hygienic stainless steel design
- Easy to clean chemically resistant housing featuring IP65 / IP67, 4X Rating
- AS-Interface or DeviceNet Fieldbus communication

Benefits

- Easy and safe Start-up through Teach function
- Easy process monitoring and error detection through clearly visible high-power coloured LEDs
- High plant availability due to prolonged actuator life boosted by spring chamber ventilation
- Minimised space requirement in the plant piping for more flexibility in plant design

Pneumatic Control Unit / Feedback



Type 8690
 Actuator size Ø 70/90/130 mm

[More info.](#)



Type 8697
 Actuator size Ø 50 mm

[More info.](#)

The pneumatic control unit Type 8697/8690 is optimised for integrated mounting on the 21XX process valve series. Mechanical or inductive limit switches register the position of the valve. The integrated pilot valve controls single or double-acting (8690) actuators.

Features

- Visual position indicator
- Mechanical or inductive limit switches for end position registering
- Pilot valve with manual override
- Compact design
- Easy to clean chemically resistant housing featuring IP65 / IP67, 4X Rating
- Optional intrinsically safe version acc. to ATEX

Benefits

- Easy and safe Start-up through Teach function (Type 8697)
- High level of signal reliability thanks to self adjusting limit switches
- Minimised space requirement in the plant piping for more flexibility in plant design

Click on the orange box "More info"... you will come to our website for the resp. product where you can download the data sheet.

Technical data, *continued*

Port connections	
Weld end	<ul style="list-style-type: none"> • DIN EN ISO 1127 / ISO 4200 / DIN 11866 Series B • DIN 11850 Series 2 / DIN 11866 Series A
Clamp	<ul style="list-style-type: none"> • ASME BPE / DIN 11866 Series C • DIN 32676 Series A (DIN tube) • DIN 32676 Series B (ISO tube) • ASME BPE
Installation for self-draining	
Inclined 3 ... 5° downwards	

¹⁾ Advanced PTFE/EPDM is recommended for sterilization cycle

Technical data valves

K_v values

Port size		K _v value water (m ³ /h)	Actuator size Ø [mm]	Permitted pilot pressure [bar]		Max. operating pressure [bar] for seal material	
[mm]	[inch]			min.	max.	EPDM, FKM [bar]	PTFE/EPDM, advanced PTFE/ EPDM [bar]
8	¼"	1.0	50	5	10	10	10
10	⅜"	1.0	50	5	10	10	10
15	½"	5.5	70	5	10	10	10
20	¾"	10.0	70	5	10	10	10
25	1"	14.0	70	5	10	6.5	6
			90	5.5	10	10	8
40	1 ½"	30.0	130	5.0	7	10	10
50	2"	51.5	130	5.0	7	8	7

Flow rate: K_v value water (m³/h)

Measured at + 20 °C, 1 bar pressure at valve inlet and free outlet.

Pressure values (bar)

Measured as overpressure to the atmospheric pressure.

Approvals/certifications

Suitability for foodstuffs / sterile applications



- The composition of the EPDM (AD), PTFE/EPDM (EA), advanced PTFE/EPDM (EU) and GYLON®/EPDM laminated (ER) diaphragms corresponds to the Code of Federal Regulations, published by the FDA (Food and Drug Administration, USA).



- The composition of the EPDM (AD), PTFE/EPDM (EA), advanced PTFE/EPDM (EU) and GYLON®/EPDM laminated (ER) diaphragms is suitable for the application with food and beverage (acc. to EC-Regulation 1935/2004/EC)
- The composition of the EPDM (AD), PTFE/EPDM (EA), advanced PTFE/EPDM (EU) and GYLON®/EPDM laminated (ER) diaphragms are approved acc. USP Class VI
- Approval according to TA-air (Port size DN4 ... 50)



- The Diaphragm valve according to 3-A approved on request (3-A Sanitary Standards Symbol Administrative Council)

Materials

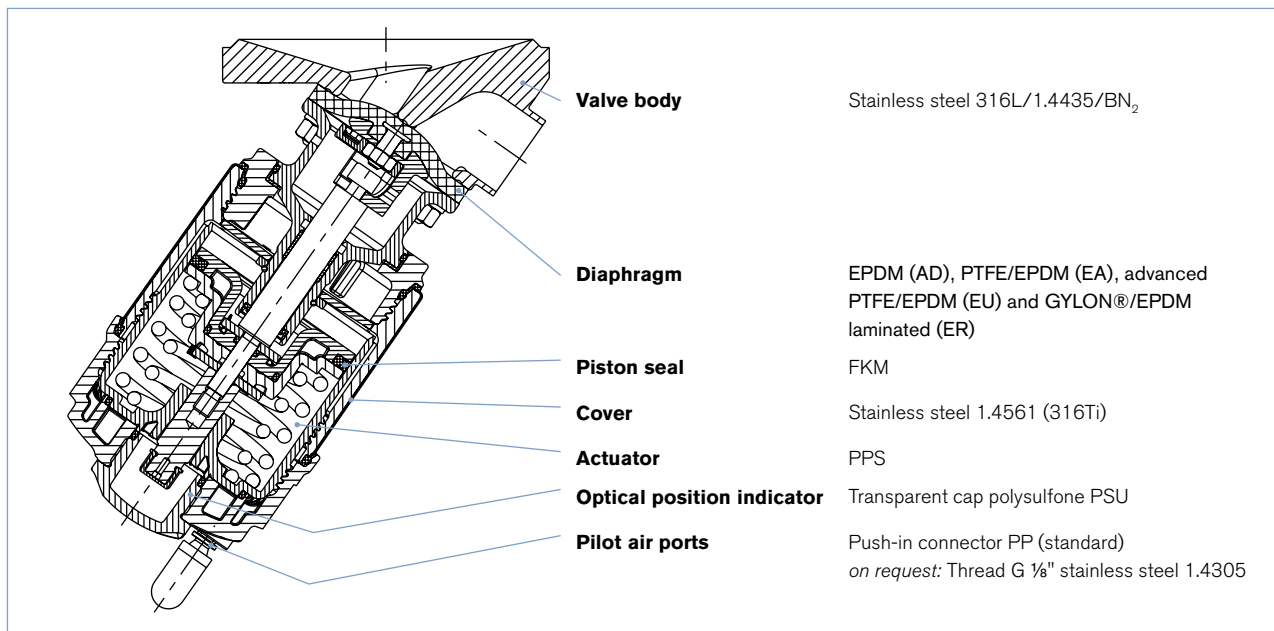

Example of available diaphragm materials

Developed to handle the unique challenges of hygienic and sterile applications, Bürkert offers diaphragms with precise material formula and physical tolerances. Bürkert diaphragms are available in a wide range of materials which have been proven in food & beverage, biotechnology, pharmaceutical and cosmetic industry applications. Bürkert diaphragms are available in a wide range of materials which have been proven in food & beverage, biotechnology, pharmaceutical and cosmetic industry applications. Diaphragms are tested during development and production to ensure reliability in critical processing environments.



- EPDM (AD)
- PTFE/EPDM (EA)
- advanced PTFE/EPDM (EU)
- FKM (FF)
- Gylon®/EPDM laminated (ER)

Dimensions [mm]

Welded body acc. to DIN EN ISO 1127 / ISO 4200 / DIN 11866 Series B and ASME BPE

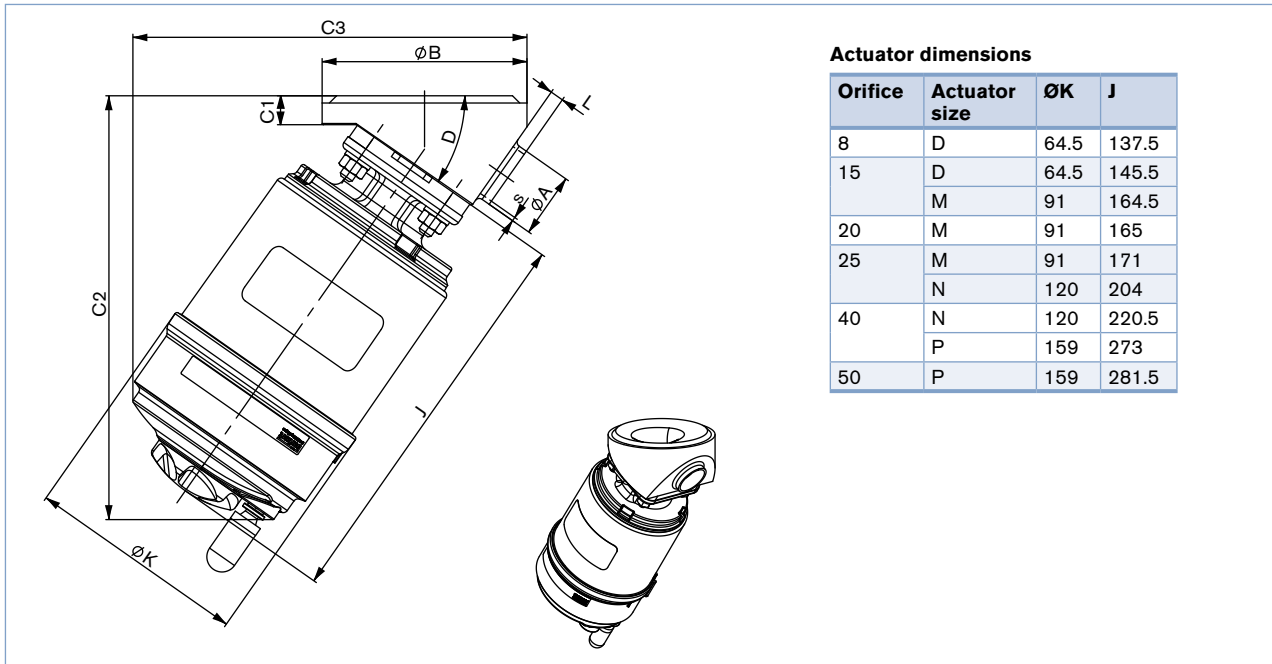

Actuator dimensions

Orifice	Actuator size	ØK	J
8	D	64.5	137.5
15	D	64.5	145.5
	M	91	164.5
20	M	91	165
25	M	91	171
	N	120	204
40	N	120	220.5
	P	159	273
50	P	159	281.5

ISO Version

DN-Seat	DN-Orifice	Actuator size	ØA ±0.1	s ±0.1	ØB ±2	C1	C2 ±2	C3 ±2	D	L
08	08	D	13.5	1.6	50	8	139	121	35°	5
15	15	D	21.3	1.6	65	12	152	137.5	35°	3
		85			172.5			156		8
20	20	M	26.9	1.6	85	12	176	163.5	35°	5.6
25	25	M	33.7	2	120	16	187.5	177	35°	8
		N						215		
40	32	N	42.4	2	150	18	239	241	35°	20
	40		48.3	2						15
40	32	P	42.4	2	150	18	287.5	287.5	35°	20
	40		48.3	2						15
50	50	P	60.3	2	180	22	302.5	302	35°	12

ASME Version

DN-Seat	DN-Orifice	Actuator size	ØA ±0.1	s ±0.1	ØB ±2	C1	C2 ±2	C3 ±2	D	L
08	08	D	6.35	0.89	50	8	139	121	35°	9
15	15	D	12.7	1.65	85	12	152	137.5	35°	10
		172.5						156		
20	20	M	19.05	1.65	85	12	176	163.5	35°	8
25	25	M	25.4	1.65	120	16	187.5	177	35°	8
		N						215		
40	40	N	38.1	1.65	150	18	239	241	35°	15
		P						287.5		
50	50	P	50.8	1.65	180	22	302.5	302	35°	15

Dimensions [mm], *continued*

Welded body acc. to DIN 11850 Series 2 / DIN 11866 Series A and SMS 3008

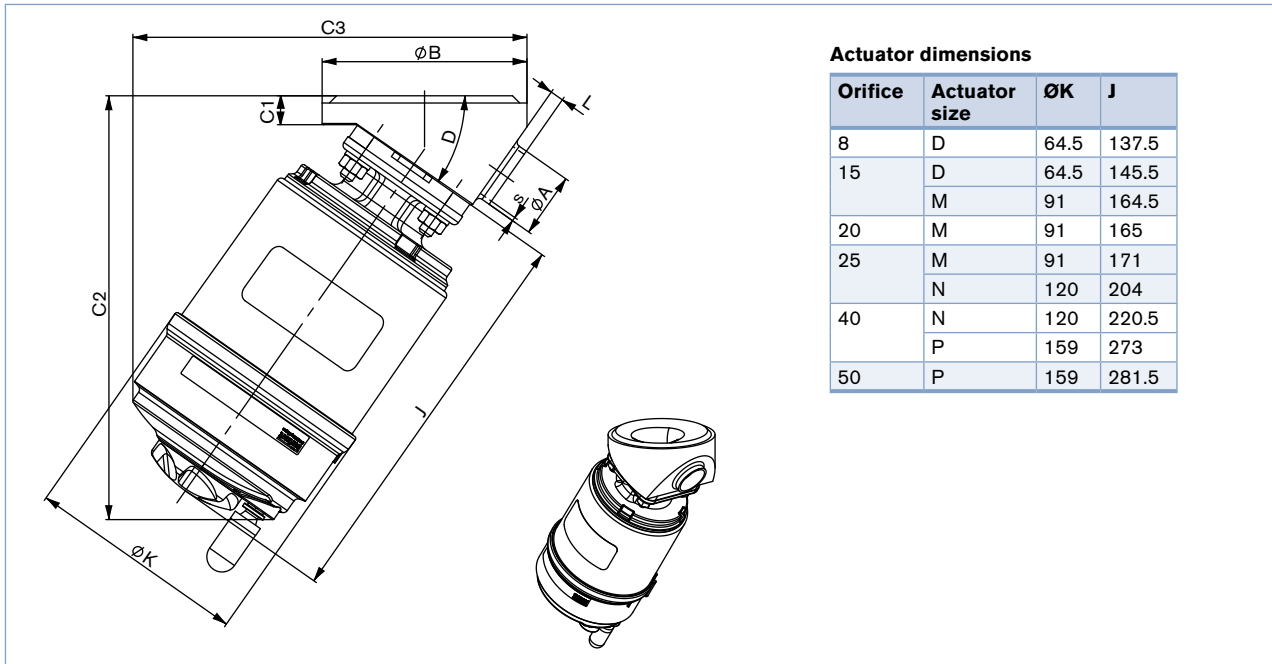

Actuator dimensions

Orifice	Actuator size	ØK	J
8	D	64.5	137.5
15	D	64.5	145.5
	M	91	164.5
20	M	91	165
25	M	91	171
	N	120	204
40	N	120	220.5
	P	159	273
50	P	159	281.5

DIN / S.2 Version

DN-Seat	DN-Orifice	Actuator size	ØA ± 0.1	s ± 0.1	ØB ± 2	C1	C2 ± 2	C3 ± 2	D	L
08	08	D	13	1.5	50	8	139	121	35°	6
15	15	D	19	1.5	85	12	152	137.5	35°	8
		M					172.5	156		
20	20	M	23	1.5	85	12	176	163.5	35°	7
25	25	M	29	1.5	120	16	187.5	177	35°	8
		N					215	201		
40	40	N	41	1.5	150	18	239	241	35°	20
		P					287.5	287.5		
50	50	P	53	1.5	180	22	302.5	302	35°	15

SMS Version

DN-Seat	DN-Orifice	Actuator size	ØA ± 0.1	s ± 0.1	ØB ± 2	C1	C2 ± 2	C3 ± 2	D	L
25	25	M	25	1.2	120	16	187.5	177	35°	8
		N					215	201		
50	50	P	51	1.2	180	22	302.5	302	35°	15

Dimensions [mm], *continued*

Clamp body

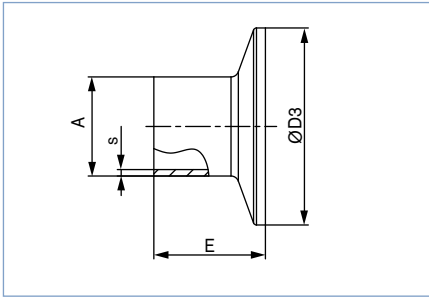

ASME BPE

Orifice [mm]	Orifice [inch]	A	s	D3	E
08	¼"	6.35	0.89	25.0	28.6
10	⅜"	9.53	0.89	25.0	28.6
15	½"	12.7	1.65	25.0	28.6
20	¾"	19.05	1.65	25.0	28.6
25	1"	25.4	1.65	50.5	28.6
40	1 ½"	38.1	1.65	50.5	28.6
50	2"	50.8	1.65	64.0	28.6

DIN 32676 Series A (DIN tube)

Orifice [mm]	A	s	D3	E
10	18	1.5	34.0	18
15	19	1.5	34.0	18
20	23	1.5	34.0	18
25	29	1.5	50.5	21.5
32	35	1.5	50.5	21.5
40	41	1.5	50.5	21.5
50	53	1.5	64.0	21.5

DIN 32676 Series B (ISO tube)

Orifice [mm]	A	s	D3	E
8	13.5	1.6	25.0	28.6
8	13.5	1.6	34.0	28.6
10	17.2	1.6	34.0	28.6
15	21.3	1.6	34.0	28.6
15	21.3	1.6	50.5	28.6
20	26.9	1.6	50.5	28.6
25	33.7	2	50.5	28.6
32	42.4	2	50.5	28.6
40	48.3	2	64.0	28.6
50	60.3	2	77.5	28.6

SMS 3017

Orifice [mm]	A	s	D3	E
25	25	1.2	50.5	21.5
40	38	1.2	50.5	28.6
50	51	1.2	64.0	28.6

Dimensions Valve system On/Off ELEMENT Type 8801-TC [mm]

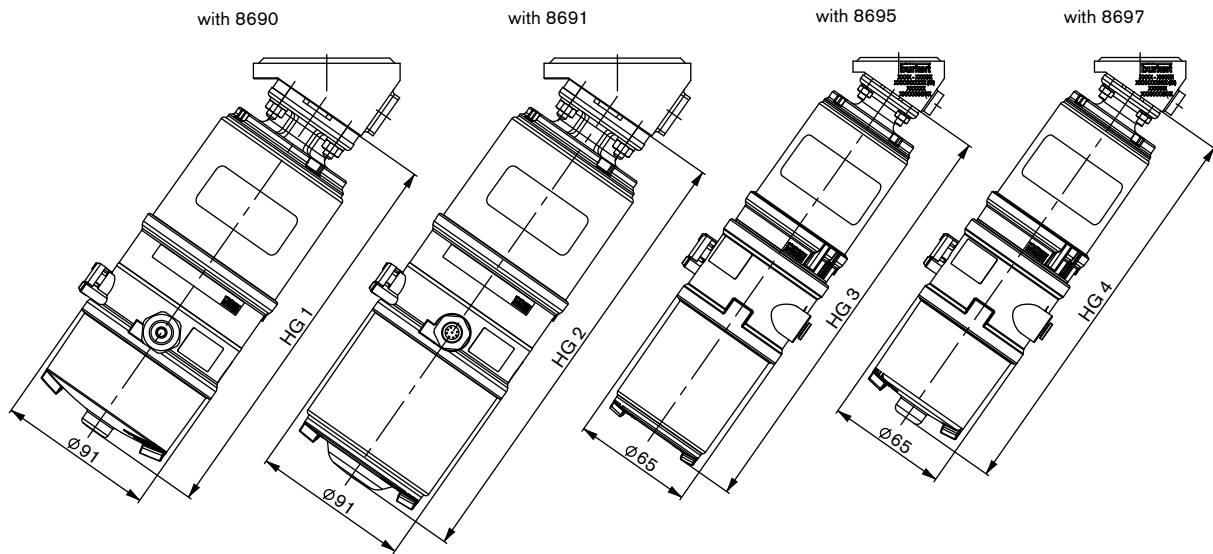

Nominal seat [mm]	Actuator size [mm]	HG 1 [mm]
15	70	227.5
20	70	228
25	70	234
	90	267
40	90	283.5
	130	336
50	130	344.5

Nominal seat [mm]	Actuator size [mm]	HG 2 [mm]
15	70	260.5
20	70	261
25	70	267
	90	300
40	90	316.5
	130	369
50	130	377.5

Nominal seat [mm]	Actuator size [mm]	HG 3 [mm]
8	50	231
15	50	239

Nominal seat [mm]	Actuator size [mm]	HG 4 [mm]
8	50	217.5
15	50	225.5

Note

You can fill out the fields directly in the PDF file before printing out the form.

Valve system On/Off Element Type 8801-TC – Request for quotation

▶ Please fill out and send to your nearest Bürkert facility* with your inquiry or order

Company	Contact person
Customer No	Department
Address	Tel./Fax
Postcode/Town	E-mail

= mandatory fields to fill out

Quantity

Required delivery date

Operating data

Pipe dimensions	Main tube ØD1 x s1	<input type="text"/>	Outlet tube ØD2 x s2	<input type="text"/>
	Clamp main tube	<input type="text"/>	Clamp outlet	<input type="text"/>
Pipe material	<input type="text"/>			
Surface finish Ra int.	<input type="text"/>			
<input type="checkbox"/> Process medium	<input type="text"/>			
<input type="checkbox"/> Type of medium	<input type="checkbox"/> Liquid	<input type="checkbox"/> Steam	<input type="checkbox"/> Gas	
<input type="checkbox"/> Flow rate (Q, QN, W) ¹⁾	nominal	unit	<input type="text"/>	
<input type="checkbox"/> Temperature at valve inlet T1	<input type="text"/>		<input type="text"/>	
<input type="checkbox"/> Absolute pressure at valve inlet P1	<input type="text"/>		<input type="text"/>	
<input type="checkbox"/> Absolute pressure at valve outlet P2	<input type="text"/>		<input type="text"/>	
Steam pressure Pv	<input type="text"/>		<input type="text"/>	

¹⁾ Standard unit:
Liquids Q = m³/h; Steam W = Kg/h; Gas QN = nm³/h

Valve features

Specification key

automatically transferred from last page









<input type="text"/>	<input type="text"/>	<input type="text"/>	<input type="text"/>	<input type="text"/>	<input type="text"/>	<input type="text"/>
----------------------	----------------------	----------------------	----------------------	----------------------	----------------------	----------------------

Continued on next page →

Valve system On/Off Element Type 8801-TC – Request for quotation, *continued*

Automation unit features

Click on the orange box "More info"... you will come to our website for the resp. product where you can download the data sheet.

Control Head		Pneumatic Control Unit / Feedback	
<input type="checkbox"/> Type 8691  For actuator size Ø 70/90/130 mm 	<input type="checkbox"/> Type 8695  For actuator size Ø 50 mm 	<input type="checkbox"/> Type 8690  For actuator size Ø 70/90/130 mm 	<input type="checkbox"/> Type 8697  For actuator size Ø 50 mm 
<ul style="list-style-type: none"> Inductive position sensor with automatic Teach function Coloured high power LEDs With/without pilot valve for single or double-acting actuators Fieldbus communication Hygienic stainless steel design 		<ul style="list-style-type: none"> visual status indicator Micro- or proximity switches for end position feedback With/ without pilot valve for single or double-acting actuators Optional intrinsically safe version acc. to ATEX / IECEx 	
Pneumatic function <input type="checkbox"/> Single-acting <input type="checkbox"/> Double-acting <input type="checkbox"/> Without pilot valve	Electrical connection <input type="checkbox"/> Cable gland <input type="checkbox"/> M12 connector	Pneumatic function <input type="checkbox"/> Single-acting <input type="checkbox"/> Double-acting (only with 8690) <input type="checkbox"/> Without pilot valve	Number of Position feedback switches <input type="checkbox"/> 1x <input type="checkbox"/> 2x
Communication <input type="checkbox"/> AS-Interface <input type="checkbox"/> DeviceNet <input type="checkbox"/> without	Approvals <input type="checkbox"/> ATEX cat. 3GD, IECEx <input type="checkbox"/> without	Position feedback switches <input type="checkbox"/> Micro-switch 24 V DC <input type="checkbox"/> Micro-switch 50 ... 225 V DC/AC (only 8697) <input type="checkbox"/> Inductive switch 3-wire PNP <input type="checkbox"/> Inductive switch 2-wire NAMUR <input type="checkbox"/> Inductive switch 2-wire 24 V DC <input type="checkbox"/> without	Electrical connection <input type="checkbox"/> Cable gland <input type="checkbox"/> M12 connector
		Approvals <input type="checkbox"/> ATEX cat. 3GD, IECEx <input type="checkbox"/> ATEX cat. 2DG, IECEx <input type="checkbox"/> without	

Certifications

- Attestation of compliance with the order EN-ISO 10204 2.1 (Item-No. 440 788)
- Test report EN-ISO 10204 2.2 (Item-No. 803 722)
- Certification of Conformity for Raw Material EN-ISO 10204 3.1 (Included in delivery)
- EN161 (European Gas Device guideline)
- Certification according to FDA - USP

Comment /sketch

Valve features

Example

A 15 AD VH FO50 SA42 NO19 + NO14 + NK52

Specification key

Please make a choice

CONTROL FUNCTION

A	Normally closed by spring action
B	normally open by spring action
I	double acting

Diaphragm size

8
15
20
25
40
50

SEAL MATERIAL

AD	EPDM
EA	PTFE/EPDM
EU	advanced PTFE/EPDM
ER	Gylon®/EPDM laminated
FF	FKM

Body material

VH	1.4435/AISI 316 L
VI	1.4435 acc. to BN2/ASME

FLANGE

FO50	DN08 (Ø 50 mm)
F085	DN15 (Ø 85 mm)
F085	DN20 (Ø 85 mm)
F120	DN25 (Ø 120 mm)
F150	DN40 (Ø 150 mm)
F180	DN50 (Ø 180 mm)
F225	DN80 (Ø 225 mm)
F300	DN100 (Ø 300 mm)

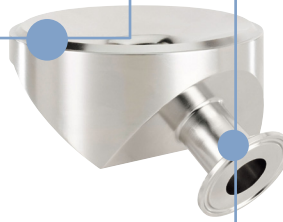

VARIABLE CODES

Surface finish external		
-	gespant Ra ≤ 1.6 µm	standard
NO19	mechanical polished Ra ≤ 1.6 µm	
NO02	mechanical polished Ra ≤ 0.76 µm	
NO28	electro polished Ra ≤ 1.6 µm	
NO15	electro polished Ra ≤ 0.76 µm	
Surface finish, internal		
NO14	mechanical polished Ra ≤ 0.5 µm (ASME BPE SF1)	standard
NO06	mechanical polished Ra ≤ 0.76 µm (ASME BPE SF3 / DIN H2)	
NO17	electro polished Ra ≤ 0.38 µm (ASME BPE SF4 / DIN HE4)	standard
NO16	electro polished Ra ≤ 0.6 µm (ASME BPE SF6)	
Certificate		
NK52	3.1 Certificate	

DN [mm]	Port connection weld end							
	EN ISO 1127/ ISO 4200 DIN 11866 S. B	SMS 3008	DIN 11850 S. 0	DIN 11850 S. 1	DIN 11850 S. 2 DIN 11866 S. A	DIN 11850 S. 3	BS 4825	ASME BPE DIN 11866 S. C
4			SC40 - 6.0 × 1.0					
6	SA78 - 10.2 × 1.6		SC41 - 8.0 × 1.0					SA89 - 3.17 × 0.56
8	SA40 - 13.5 × 1.6		SC42 - 10.0 × 1.0				SODB - 6.35 × 1.2	SA90 - 6.35 × 0.89
10	SA41 - 17.2 × 1.6			SF40 - 12.0 × 1.0	SD40 - 13.0 × 1.5	SE40 - 14.0 × 2.0	SODC - 9.53 × 1.2	SA91 - 9.53 × 0.89
15	SA42 - 21.3 × 1.6	SA58 - 12.0 × 1.0	SC43 - 18.0 × 1.5	SF41 - 18.0 × 1.0	SD42 - 19.0 × 1.5	SE42 - 20.0 × 2.0	SODD - 12.7 × 1.2	SA92 - 12.7 × 1.65
20	SA43 - 26.9 × 1.6	SA59 - 18.0 × 1.0	SC44 - 22.0 × 1.5	SF42 - 22.0 × 1.0	SD43 - 23.0 × 1.5	SE43 - 24.0 × 2.0	SODE - 19.05 × 1.2	SA93 - 19.05 × 1.65
25	SA44 - 33.7 × 2.0	SA60 - 25.0 × 1.2	SC45 - 28.0 × 1.5	SF43 - 28.0 × 1.0	SD44 - 29.0 × 1.5	SE44 - 30.0 × 2.0		SODF - 25.4 × 1.65
32	SA45 - 42.4 × 2.0	SA61 - 33.7 × 1.2	SC46 - 34.0 × 1.5	SF44 - 34.0 × 1.0	SD45 - 35.0 × 1.5	SE45 - 36.0 × 2.0		
40	SA46 - 48.3 × 2.0	SA62 - 38.0 × 1.2	SC47 - 40.0 × 1.5	SF45 - 40.0 × 1.0	SD46 - 41.0 × 1.5	SE46 - 42.0 × 2.0		SODH - 38.1 × 1.65
50	SA47 - 60.3 × 2.0	SA63 - 51.0 × 1.2	SC48 - 52.0 × 1.5	SF46 - 52.0 × 1.0	SD47 - 53.0 × 1.5	SE47 - 54.0 × 2.0		SODI - 50.8 × 1.65
DN [mm]	Port connection Clamp					ASME BPE	BS 4825 (Clamp BS 4825 - 3, tube BS 4825 - 1)	
	Clamp 34.0 like DIN 32676 S. B (ISO - tube (ISO4200))	DIN 32676 S. A (DIN - tube (DIN11850))	DIN 32676 S. B (ISO - tube (ISO4200))					
8	TC51 - 13.5 × 1.6 Cl: 34.0	TD40 - 10.0 × 1.0 Cl: 25.0	TC40 - 13.5 × 1.6 Cl: 25.0	TG 50 - 6.35 × 0.89 Cl: 25.0				
10	TC41 - 17.2 × 1.6 Cl: 34.0	TD41 - 13.0 × 1.5 Cl: 34.0	TC53 - 17.2 × 1.6 Cl: 25.0	TG 01 - 9.53 × 0.89 Cl: 25.0				
15	TC42 - 21.3 × 1.6 Cl: 34.0	TD42 - 19.0 × 1.5 Cl: 34.0	TC52 - 21.3 × 1.6 Cl: 50.5	TG 02 - 12.7 × 1.65 Cl: 25.0		TH42 - 12.7 × 1.2 Cl: 25.0		
20		TD43 - 23.0 × 1.5 Cl: 34.0	TC43 - 26.9 × 1.6 Cl: 50.5	TG 03 - 19.05 × 1.65 Cl: 25.0		TH43 - 19.05 × 1.2 Cl: 25.0		
25		TD44 - 29.0 × 1.5 Cl: 50.5	TC44 - 33.7 × 2.0 Cl: 50.5	TG 04 - 25.4 × 1.65 Cl: 50.5				
32								
40		TD46 - 41.0 × 1.5 Cl: 50.5	TC46 - 48.3 × 2.0 Cl: 64.0	TG 05 - 38.1 × 1.65 Cl: 50.5				
50		TD47 - 53.0 × 1.5 Cl: 64.0	TC47 - 60.3 × 2.0 Cl: 77.5	TG 06 - 50.8 × 1.65 Cl: 64.0				

In case of special application conditions, please consult for advice.

Subject to alteration
© Christian Bürkert GmbH & Co. KG

1802/8_EUen_00895245